

MIDGET MIXERS FORCED AIR

MODEL: 2351-MM-THRU-MMTR

Revision: 0

BULLETIN
2351

DESCRIPTION

Midget Mixers (MM) are suction type proportional air-gas mixers. Air passing through the jet produces a suction in the throat section to entrain a fuel gas.

The quantity of gas entrained is easily set by the adjuster plug in the gas throttle cock. Once set, the fuel to air ratio remains constant over a wide range of air flows (assuming a constant gas pressure).

A Zero Regulator can be used to maintain a constant gas pressure, precisely at atmospheric pressure, for all gas flows.

Total heat input of the mixture delivered to the burner system is controlled by a single valve in the combustion air line. This valve may be motor operated for automatic process control.

The MMSR, MMCR, and MMTR assemblies include a correctly sized midget Zero Regulator. The accuracy of these units permits turndown ranges up to 3:1 on a capacity basis. Where wide turndown ranges are required, or where a number of mixers are connected to a single regulator, the 'BZR' Series Regulators (see Bulletin 5101) are recommended.

Blast Tip Burners (see Bulletin 3110) are designed to match the 'MM' Series Mixers.



CAPACITY TABLE

Basic Model Number	Minimum Burner Port Area (Based on 90% Coefficient of Discharge)	Capacities in 1000 Btu/Hr. for Various Air Pressures Based on 100% Primary Air			
		4 osi	8 osi	16 osi	24 osi
		Mixture Pressure			
		2" W.C.	4" W.C.	8" W.C.	12" W.C.
1MM	0.0264	3.5	5.0	7.0	8.5
2MM	0.0515	7.0	10.0	14.0	17.0
3MM	0.0671	9.0	12.0	18.0	22.0
4MM	0.0971	14.0	19.0	27.0	33.0
6MM	0.1820	25.0	35.0	50.0	61.0
8MM	0.2500	50.0	70.0	100.0	120.0

FEATURES

- Compact sizes
- Soldered bodies
- Single valve control
- Rugged construction
- Plated surfaces
- Ratio easily set
- Marked inlets

CAUTION: Operation of combustion equipment can be hazardous resulting in bodily injury or equipment damage. Each burner should be supervised by a combustion safeguard and only qualified personnel should install, make system adjustments and perform any required service.



pyronics inc.

COMBUSTION FOR INDUSTRY

17700 MILES ROAD
CLEVELAND, OH 44128
www.pyronics.com

Tel: 216-662-8800
Fax: 216-663-8954
marketing@pyronics.com

NOTICE: PYRONICS practices a policy of continuous improvement in the design of its products. It reserves the right to change the specifications at any time without prior notice.

MIDGET MIXERS FORCED AIR

BULLETIN 2351
PAGE NO. 2

MIDGET MIXER SELECTION

1. The capacities listed are based on 100% primary air operation.
2. Determine the maximum BTU/hr. capacity of the burner or burners to be used with each mixer at the mixer pressure corresponding to the air pressure available.
3. Multiply the total capacity in Step 2 by the primary aeration percentage (air/gas ratio) required by the burners.
4. Select the correct Midget Mixer based on this capacity. If the selection capacity falls between two sizes, select the smaller size.
5. Select the 'BZR' or 'G.P.A.' Series Regulator (if required) based on the total BTU/hr. capacity of the burners determined in Step 2.

INSTALLATION AND ADJUSTMENT

1. The mixer may be installed in any position.
2. The diaphragm case of the gas regulators must be horizontal. The stem of the Midget Zero Regulators (supplied on MMSR, MMCR, and MMTR assemblies), must be up. The stem of the 'BZR' Series Regulators must be up.
3. The gas and air piping connections are marked on the mixer bodies. Piping to these connections should be sized large enough to minimize pressure losses.
4. 'BZR' and Midget Zero Regulators should be mounted as close as possible to the gas ratio throttle cocks.
5. A single Regulator ('BZR' type) may be manifolded to a group of MMS, MMC, or MMT assemblies. The piping between the Regulator and mixers must be sized so that pressure losses are less than 0.1" w.c. at maximum flow rates.
6. Piping from the mixer outlet to burner or burners must be at least as large as the mixer outlet pipe size. No valves or other restriction are permitted in this pipe. If long runs or more than one elbow are required, the mixture piping size should be increased to reduce pressure losses below 0.5" w.c.
7. **To Light Burners** - Open fully gas throttle cock at mixer and remove adjustment cap (in the center of the cock handle).
8. Open air cock, apply lighter to burners, and adjust gas throttle (under cap of gas cock) for desired flame.
9. Open air cock full and check flame characteristic. Readjust, if necessary.
10. MMT assemblies use a throttle cock in the air line to accurately set the heat input and duplicate the setting on each start up.

MIDGET MIXERS FORCED AIR

BULLETIN 2351
PAGE NO. 3

MODEL IDENTIFICATION

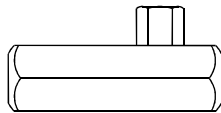
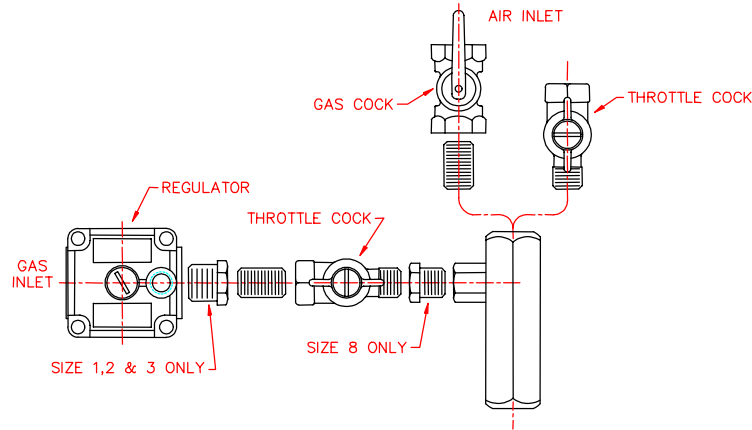

MM Series

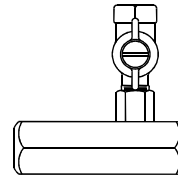

MMS Series

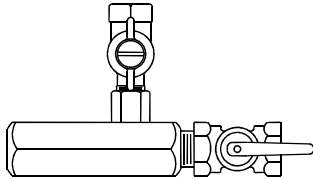

MMC Series

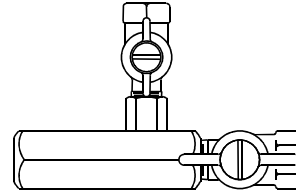

** MMT Series

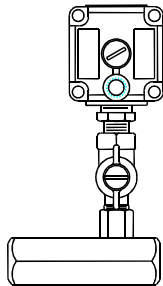

MMSR Series

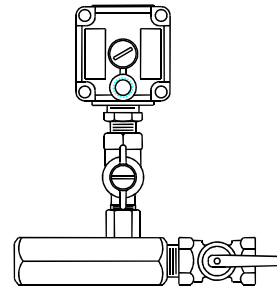

MMCR Series

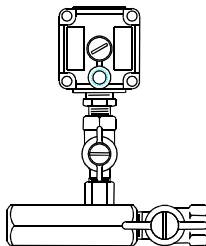

** MMTR Series

** -- Only available in sizes 1 thru 3

CAUTION: Operation of combustion equipment can be hazardous resulting in bodily injury or equipment damage. Each burner should be supervised by a combustion safeguard and only qualified personnel should install, make system adjustments and perform any required service.



pyronics inc.

COMBUSTION FOR INDUSTRY
17700 MILES ROAD
CLEVELAND, OH 44128
www.pyronics.com

Tel: 216-662-8800
Fax: 216-663-8954
marketing@pyronics.com

NOTICE: PYRONICS practices a policy of continuous improvement in the design of its products. It reserves the right to change the specifications at any time without prior notice.

MIDGET MIXERS FORCED AIR

BULLETIN 2351
PAGE NO.4

DIMENSIONS

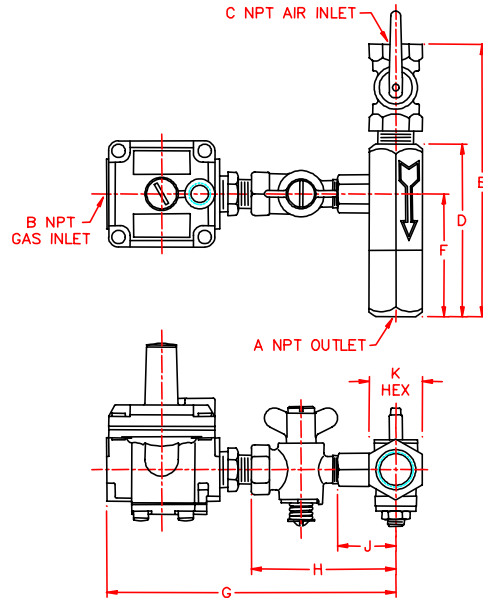

Model Number	A	B	C	D	E	F	G	H	J	K	Weight	
											Lbs.	Kgs.
1MM	1/8	1/4	1/4	2-7/16	----	1-1/2	----	----	1-1/8	1	0.5	0.23
2MM	1/4	1/4	1/4	2-7/8	----	1-15/16	----	----	1-1/8	1	0.6	0.28
3MM	3/8	1/4	3/8	3-1/4	----	2-5/16	----	----	1-1/8	1	0.6	0.28
4MM	1/2	3/8	1/2	3-7/8	----	2-5/8	----	----	1-1/4	1-1/4	1.1	0.51
6MM	3/4	3/8	3/4	4-1/8	----	2-7/8	----	----	1-1/4	1-1/4	1.0	0.45
8MM	1	1/2	1	5-7/16	----	3-9/16	----	----	1-5/8	1-5/8	2.7	1.22
1MMS	1/8	1/4	1/4	2-7/16	----	1-1/2	----	2-3/4	1-1/8	1	0.8	0.34
2MMS	1/4	1/4	1/4	2-7/8	----	1-15/16	----	2-3/4	1-1/8	1	1.0	0.45
3MMS	3/8	1/4	3/8	3-1/4	----	2-5/16	----	2-3/4	1-1/8	1	1.0	0.45
4MMS	1/2	3/8	1/2	3-7/8	----	2-5/8	----	3	1-1/4	1-1/4	1.7	0.76
6MMS	3/4	3/8	3/4	4-1/8	----	2-7/8	----	3	1-1/4	1-1/4	1.6	0.74
8MMS	1	3/8	1	5-7/16	----	3-9/16	----	3-3/4	1-5/8	1-5/8	3.3	1.51
1MMC	1/8	1/4	1/4	2-7/16	4-3/16	1-1/2	----	2-3/4	1-1/8	1	1.3	0.59
2MMC	1/4	1/4	1/4	2-7/8	4-5/8	1-15/16	----	2-3/4	1-1/8	1	1.5	0.68
3MMC	3/8	1/4	3/8	3-1/4	5-1/8	2-5/16	----	2-3/4	1-1/8	1	1.5	0.68
4MMC	1/2	3/8	1/2	3-7/8	6-1/8	2-5/8	----	3	1-1/4	1-1/4	2.3	1.05
6MMC	3/4	3/8	3/4	4-1/8	7-5/16	2-7/8	----	3	1-1/4	1-1/4	2.2	0.99
8MMC	1	3/8	1	5-7/16	8-11/16	3-9/16	----	3-3/4	1-5/8	1-5/8	3.9	1.76
1MMT	1/8	1/4	1/4	2-7/16	4-1/16	1-1/2	----	2-3/4	1-1/8	1	1.1	0.51
2MMT	1/4	1/4	1/4	2-7/8	4-1/2	1-15/16	----	2-3/4	1-1/8	1	1.3	0.59
3MMT	3/8	1/4	3/8	3-1/4	5	2-5/16	----	2-3/4	1-1/8	1	1.5	0.68
1MMSR	1/8	3/8	1/4	2-7/16	----	1-1/2	5-7/16	2-3/4	1-1/8	1	1.3	0.59
2MMSR	1/4	3/8	1/4	2-7/8	----	1-15/16	5-7/16	2-3/4	1-1/8	1	1.4	0.65
3MMSR	3/8	3/8	3/8	3-1/4	----	2-5/16	5-7/16	2-3/4	1-1/8	1	1.4	0.65
4MMSR	1/2	3/8	1/2	3-7/8	----	2-5/8	5-3/8	3	1-1/4	1-1/4	2.1	0.96
6MMSR	3/4	3/8	3/4	4-1/8	----	2-7/8	5-3/8	3	1-1/4	1-1/4	2.0	0.91
8MMSR	1	3/8	1	5-7/16	----	3-9/16	6-1/8	3-3/4	1-5/8	1-5/8	3.7	1.68
1MMCR	1/8	3/8	1/4	2-7/16	4-3/16	1-1/2	5-7/16	2-3/4	1-1/8	1	1.8	0.82
2MMCR	1/4	3/8	1/4	2-7/8	4-5/8	1-15/16	5-7/16	2-3/4	1-1/8	1	1.9	0.88
3MMCR	3/8	3/8	3/8	3-1/4	5-1/8	2-5/16	5-7/16	2-3/4	1-1/8	1	1.9	0.88
4MMCR	1/2	3/8	1/2	3-7/8	6-1/8	2-5/8	5-3/8	3	1-1/4	1-1/4	2.8	1.27
6MMCR	3/4	3/8	3/4	4-1/8	7-5/16	2-7/8	5-3/8	3	1-1/4	1-1/4	2.7	1.22
8MMCR	1	3/8	1	5-7/16	8-11/16	3-9/16	6-1/8	3-3/4	1-5/8	1-5/8	4.4	1.99
1MMTR	1/8	3/8	1/4	2-7/16	4-1/16	1-1/2	5-7/16	2-3/4	1-1/8	1	1.6	0.74
2MMTR	1/4	3/8	1/4	2-7/8	4-1/2	1-15/16	5-7/16	2-3/4	1-1/8	1	1.7	0.76
3MMTR	3/8	3/8	3/8	3-1/4	5	2-5/16	5-7/16	2-3/4	1-1/8	1	1.9	0.88

ORDERING INFORMATION

1. Specify Model Number and Quantity of Mixers.
2. Specify Model Number and Quantity of BZR Regulators (if required).
3. Shipping Instructions

The content on or accessible through CombustionDepot.com, (including, but not limited to) text, graphics and other materials, are provided by CombustionDepot.com, for informational purposes only. CombustionDepot.com does not claim ownership to any of the photos, images, or pictures of products on the site. These depictions are solely for information purposes and may not be an exact replication of the related product available for sale. All PDF and specification pages are gathered from the OEM web sites or publicly available information. CombustionDepot.com does not claim responsibility for any of the information found on these bulletins, documents, literature, specification charts, etc. and such information is subject to change without notice.