

BLOWER ASSEMBLIES

Belt Drive Blowers



Applications: Residential & Light Commercial

For performance information please refer to Appendix B

COMPLETE BLOWER ASSEMBLIES CONSIST OF:

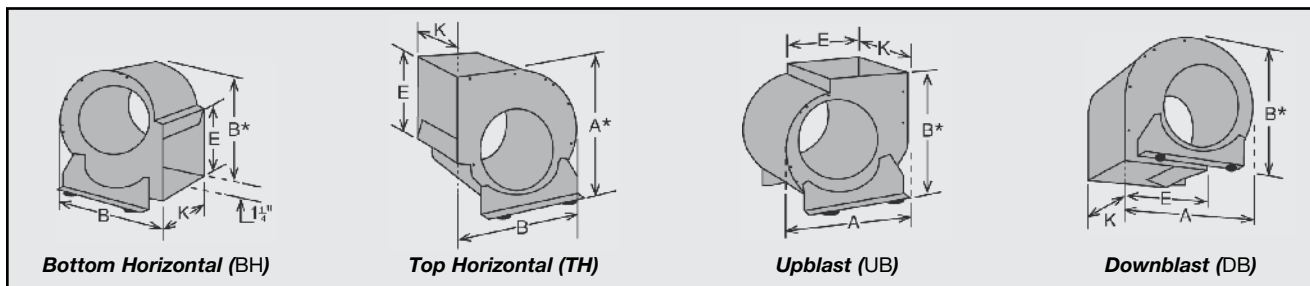
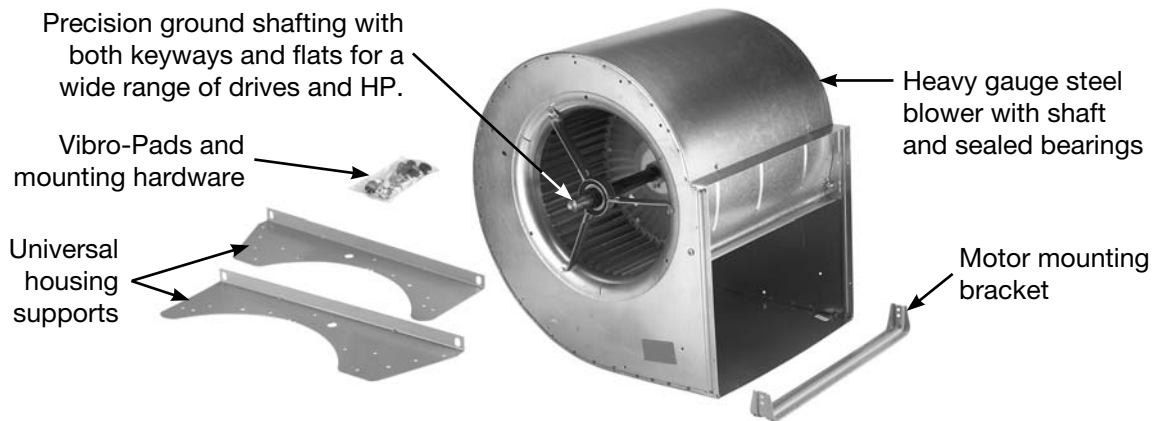

Purchase belts, motor and blower pulleys separately.

BELT DRIVE BLOWERS

Part Number	Model Number	K	E	A	B	Shaft Size
0574300001M	A9-6ACE	8 ¹ / ₄ "	10 ¹ / ₄ "	15 ⁷ / ₁₆ "	14 ¹⁵ / ₁₆ "	3/4"
0574300002M	A9-7ACE	9 ³ / ₁₆ "	10 ¹ / ₄ "	15 ⁷ / ₁₆ "	14 ¹⁵ / ₁₆ "	3/4"
0574300003M	A9-9ACE	11 ⁷ / ₈ "	10 ¹ / ₄ "	15 ⁷ / ₁₆ "	14 ¹⁵ / ₁₆ "	3/4"
0574310001M	A10-6ACE	8 ¹ / ₄ "	11 ³ / ₈ "	17 ¹ / ₄ "	16 ¹ / ₂ "	3/4"
0574310002M	A10-8ACE	10 ¹ / ₂ "	11 ³ / ₈ "	17 ¹ / ₄ "	16 ¹ / ₂ "	3/4"
0574310003M	A10-10ACE	13 ¹ / ₁₆ "	11 ³ / ₈ "	17 ¹ / ₄ "	16 ¹ / ₂ "	3/4"
3824340021M	A12-6ACE	8 ¹³ / ₁₆ "	13 ⁷ / ₁₆ "	20 ⁷ / ₁₆ "	19 ⁵ / ₁₆ "	1"
3824340022M	A12-9ACE	12 ³ / ₈ "	13 ⁷ / ₁₆ "	20 ⁷ / ₁₆ "	19 ⁵ / ₁₆ "	1"
38243420M	A12-12ACE	15 ³ / ₄ "	13 ⁷ / ₁₆ "	20 ⁷ / ₁₆ "	19 ⁵ / ₁₆ "	1"
3820800003M	A15-9ACE	12 ¹³ / ₁₆ "	15 ⁷ / ₈ "	24 ¹ / ₈ "	22 ⁵ / ₈ "	1"
3820800004M	A15-11ACE	14 ¹¹ / ₁₆ "	15 ⁷ / ₈ "	24 ¹ / ₈ "	22 ⁵ / ₈ "	1"
38208002M	A15-15ACE	18 ⁵ / ₈ "	15 ⁷ / ₈ "	24 ¹ / ₈ "	22 ⁵ / ₈ "	1"
3824300003M	A18-13ACE	17 ³ / ₈ "	18 ⁷ / ₈ "	29 ³ / ₁₆ "	27"	1"
38243002M	A18-18ACE	21 ⁷ / ₈ "	18 ⁷ / ₈ "	29 ³ / ₁₆ "	27"	1"

Maximum blower operating temperature, 150°F. **Caution:** Most motors have maximum 104°F operating temperature. Must ship via common carrier.

Specifications are subject to change without notice or obligation

Blower Selection Procedure	Example	Remarks
1. Determine blower position from diagrams on Page 36.	For our example, we'll say it is UPBLAST.	UB
2. Determine the overall dimensions for fit (see dimensions A and B).	Measure old blower.	A = 18" B = 16"
3. Determine the blower outlet dimensions (see dimensions K and E).	Measure old blower.	E = 11 ³ / ₈ " K = 13 ³ / ₄ "
4. Compare the above with the Blower Dimension Chart and select the nearest fit (K and E are critical).	Model Number Part Number	A10-10ACE 38-2076-01
5. Refer to the Blower Performance Chart (Appendix B) with the model number chosen. Select the CFM* desired, the wheel RPM, and HP under the static pressure. (+ If static pressure is unknown, use the 1" SP column.)	At 1,000 CFM and 3/4" static pressure, the wheel RPM is 843 at .30 BHP.	CFM = 1000 RPM = 843 BHP = .30
6. Refer to the Drive Chart for Belt Drive Blower Assemblies (Appendix B) to determine pulley and belt sizes required, as well as the motor mount location for same. Since the BHP is .30, the motor requirement is a minimum 1/3 HP nameplate rating. Remember , "over-motoring" or "under-motoring" will cause excessive heat for any motor.	A 10" blower with an upblast (UB) position requires motor position #2, a 3 ¹ / ₄ " motor pulley, 6" wheel pulley and a 41" belt based on 843 RPM (assumes a 48" frame motor).	Position #2 Motor Pulley = 3 ¹ / ₄ " Wheel Pulley = 6" Belt = 41" Motor: 1/3 HP
<p>NOTES:</p> <ul style="list-style-type: none"> Standard sleeve bearings are suitable for up to 3/4 HP on 9" and 10" blowers and up to 1 HP on 12" to 18" designs. Above these limits, ball bearings are required. 		
<p> Before making final selections, review Component Limits shown on Page 54.</p> <p>Standard sleeve bearings on Belt Drive Blowers can be replaced in the field using the sealed-type ball bearings on Page 56-57.</p>		

- **Converts two standard replacement blowers to a twin assembly**
- **Includes ball bearings, spreader bars, shaft, hardware and instruction manual**

 **For Twin Blower performance, use same Single Blower Performance Data but double CFM and BHP (brake horsepower) at same SP (static pressure).**

* For Blowers other than full width, redrill holes in spreader bars to match overall blower width desired. Also, cut shaft to length required. For Twin Blower assemblies larger than 15" diameter, order a complete twin assembly from the factory (allow 8 to 10 weeks lead-time).

TWIN BLOWER PARTS KIT

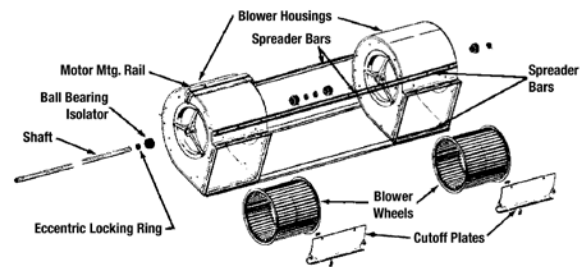

Part Number	Description	Bore Size	Shaft Length	Spreader Bar Length
02484093	2A9-6A*, 2A9-7A, 2A9-9A	3/4"	36 ¹ / ₈ "	32 ¹ / ₂ "
02484094	2A10-6A*, 2A10-8A*, 2A10-10A	3/4"	39 ³ / ₄ "	36"
02484095	2A12-6A*, 2A12-9A*, 2A12-12A	1"	47 ³ / ₈ "	43"
02484096	2A15-9A*, 2A15-11A*, 2A15-15A	1"	56 ¹ / ₄ "	52"

- **Reduces vibration, wear and noise on blowers, fans and motors**
- **Resilient rubber pads snap easily into place**
- **Packaged 12 per bag (order by part number)**

Part Number Per Doz.
38220901

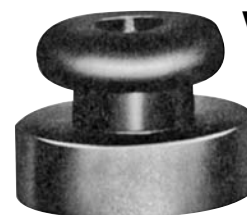

VIBRO-PADS

Specifications are subject to change without notice or obligation

BLOWER ASSEMBLIES

Direct Drive Blowers



Applications: Residential & Light Commercial

For performance information please see next page

Blowers



BOTTOM HORIZONTAL

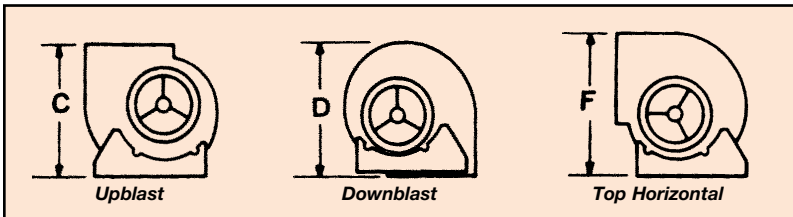
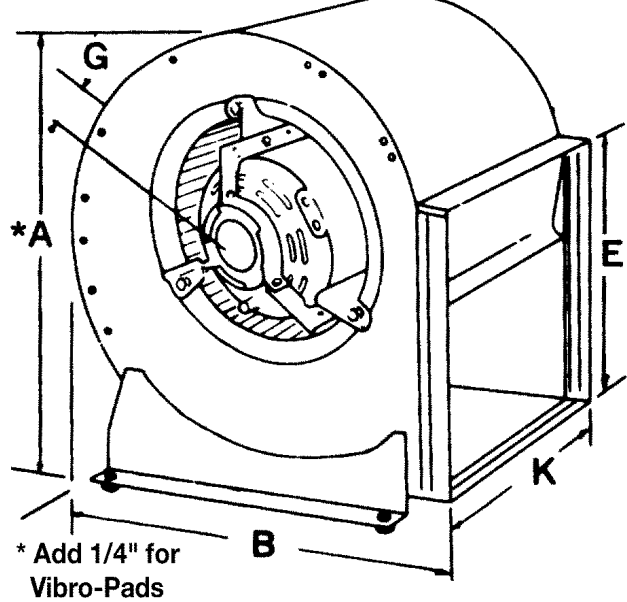

DIRECT DRIVE BLOWER ASSEMBLIES CONSIST OF:

- Heavy gauge steel blower
- Blower wheel
- Adjustable motor mounting bracket
- Vibro-Pads
- Universal housing supports

DIRECT DRIVE DIMENSIONS – CW* ROTATION

Part Number	Model Number	K	E	A	B	C	D	F	G†	Shaft Size
38251301M	DD9-7A	9 ³ / ₁₆	10 ¹ / ₄	17	14 ¹⁵ / ₁₆	15 ¹ / ₁₆	14 ¹⁵ / ₁₆	15 ⁹ / ₁₆	1 ¹ / ₄	1/2" Bore
38251302M	DD9-9A	11 ⁷ / ₈	10 ¹ / ₄	17	14 ¹⁵ / ₁₆	15 ¹ / ₁₆	14 ¹⁵ / ₁₆	15 ⁹ / ₁₆	7/8	1/2" Bore
38251303M	DD10-8A	10 ¹ / ₂	11 ³ / ₈	18 ⁷ / ₈	16 ¹ / ₂	16 ¹¹ / ₁₆	16 ¹ / ₂	17 ¹ / ₂	1 ¹ / ₈	1/2" Bore
38251304M	DD10-10A	13 ¹ / ₁₆	11 ³ / ₈	18 ⁷ / ₈	16 ¹ / ₂	16 ¹¹ / ₁₆	16 ¹ / ₂	17 ¹ / ₂	5/8	1/2" Bore
02484028M	DD12-9A	12 ¹ / ₄	13 ⁷ / ₁₆	21 ⁷ / ₈	19 ³ / ₈	19 ¹ / ₂	19 ³ / ₈	20 ¹ / ₂	1 ⁵ / ₁₆	1/2" Bore
02484029M	DD12-12A	15 ⁵ / ₈	13 ⁷ / ₁₆	21 ⁷ / ₈	19 ³ / ₈	19 ¹ / ₂	19 ³ / ₈	20 ¹ / ₂	1 ⁵ / ₁₆	1/2" Bore

† Dimensions are maximum and will vary slightly with motor sizes.

Continued on next page

To select a Direct Drive Blower, choose the matching dimensions K and E above, to match the application. Other dimensions are not as critical, assuming overall dimensions do not exceed available space.

Specifications are subject to change without notice or obligation

DIRECT DRIVE BLOWER PERFORMANCE

The following Performance Data assumes use of an off-the-shelf, 1075 RPM motor.

For exact performance in your application, contact Lau.

Model Number	Motor HP (High Speed)	.5 SP	.6 SP	.7 SP	.8 SP	.9 SP	1.0 SP	1.1 SP	1.2 SP	1.3 SP	1.4 SP	1.5 SP	1.6 SP
DD 9-7	1/4	—	—	1220	1170	1100	980	—	—	—	—	—	—
DD 9-7	1/3	1470	1490	1290	1330	1250	1100	—	—	—	—	—	—
DD 9-9	1/4	1330	1290	1240	1160	1000	—	—	—	—	—	—	—
DD 9-9	1/3	1560	1490	1430	1320	1150	—	—	—	—	—	—	—
DD 9-9	1/2	1820	1730	1620	1480	1260	—	—	—	—	—	—	—
DD10-8	1/4	—	—	—	—	—	1195	1130	1020	—	—	—	—
DD10-8	1/3	—	—	—	—	1460	1410	1360	1270	1100	—	—	—
DD10-8	1/2	—	2130	2070	2000	1930	1840	1740	1620	1450	—	—	—
DD10-10	1/3	—	—	—	—	1520	1460	1350	1000	—	—	—	—
DD10-10	1/2	—	2300	2220	2140	2060	1950	1800	1500	—	—	—	—
DD11-10*	1/2	—	—	—	—	—	—	2160	2070	1950	1750	—	—
DD12-9	1/2	—	—	—	—	—	—	—	—	1950	1910	1850	1740
DD12-12	1/2	—	—	—	—	—	—	2150	2080	1950	1600	—	—

* Reference

PREVENTATIVE MAINTENANCE FOR DIRECT DRIVE BLOWERS

Show the homeowner how they can perform basic service on the blower:



CAUTION: Make sure all electrical power is turned off and locked out to furnace or air conditioning unit before performing any maintenance.

- Follow motor manufacturer's instructions on motor nameplate.
- Oil the motor seasonally with medium weight (SAE 20) motor oil.
- Vacuum the blower and blower compartment seasonally.
- Change filters seasonally and replace when dirty.



SHIPPING NOTE:

Most Lau products can be shipped normal parcel shipping services, such as FedEx or UPS, but, some products are too large and must be shipped via common carrier.

Next Day or 2nd Day parcel services can be used to ship items at special handling costs. Because the majority of items in this catalog are bulky, we recommend checking with our Customer Service Representatives to verify pricing of expedited service.

Specifications are subject to change without notice or obligation